

7' CONCRETE BENCH

TOP VIEW

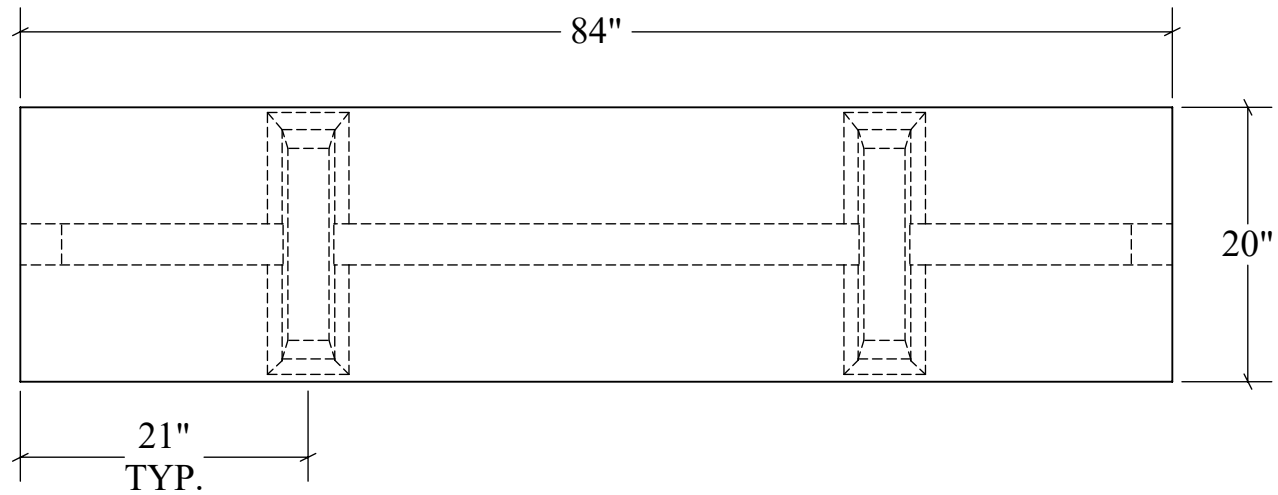

END VIEW

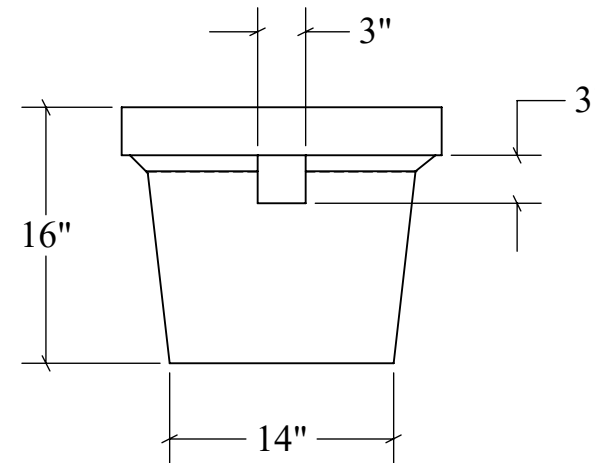

SECTION VIEW

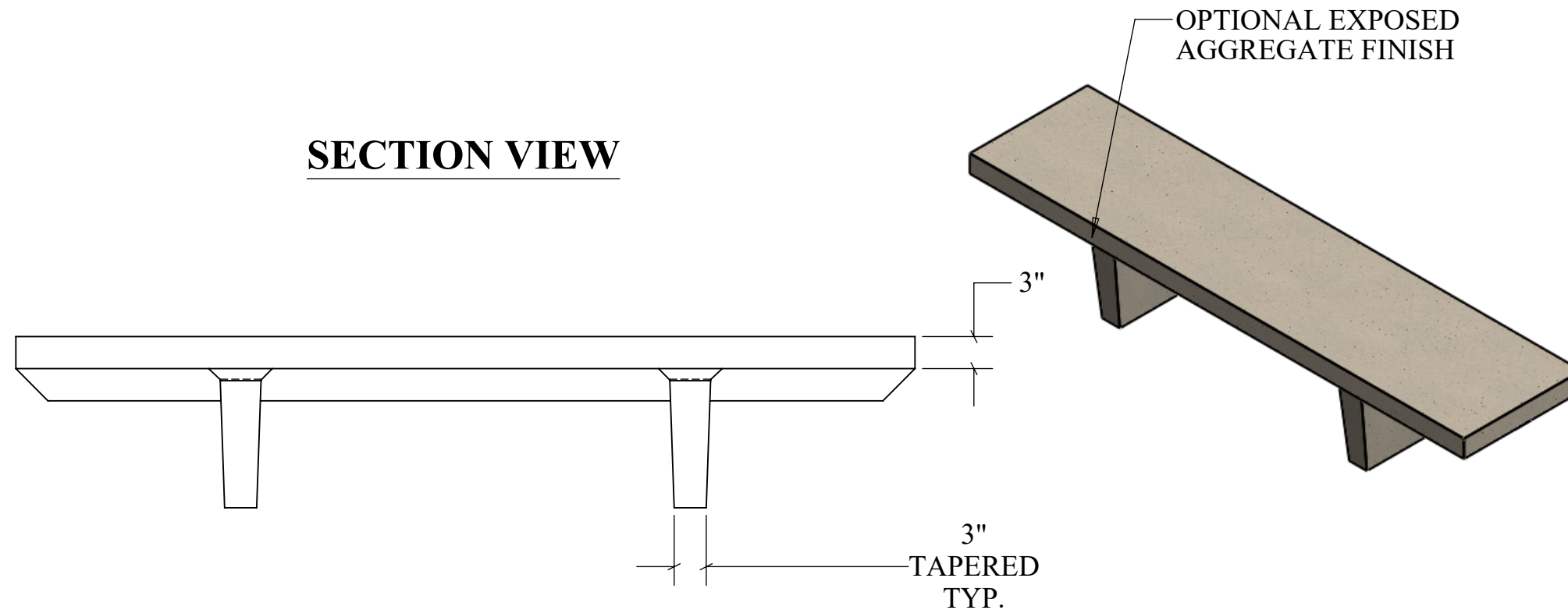

STRUCTURAL NOTES:

1. ALL CONCRETE SHALL BE PLACED IN A SINGLE CONTINUOUS OPERATION (MONOLITHIC POUR).
2. CONCRETE SHALL HAVE A MINIMUM 28-DAY COMPRESSIVE STRENGTH OF 4000 PSI CONCRETE AGGREGATE SHALL CONFORM TO ASTM C33.
3. CEMENT SHALL CONFORM TO ASTM C150, TYPE I, II, OR III.

DRAWN:
12/8/22

WEIGHT:
620 LBS.

SCALE:
VARIES

MATERIAL:
4,000 PSI
CONCRETE

FINISH:
FORM FINISH

DIMENSIONS ARE IN
FEET & INCHES
TOLERANCES: ± 4-IN.



PRECISION PRECAST

575-382-0501

SALES@PRECISIONPRECAST.CO

WWW.PRECISIONPRECAST.CO

PROPRIETARY AND CONFIDENTIAL THE INFORMATION CONTAINED IN THIS DRAWING IS THE SOLE PROPERTY OF LECO INDUSTRIES INC DBA PRECISION PRECAST. ANY REPRODUCTION PART OR AS A WHOLE WITHOUT WRITTEN PERMISSION OF LECO INDUSTRIES, INC DBA PRECISION PRECAST IS PROHIBITED.